

NB9

Nicho com divisórias e fixação invisível

Linha
Decore

FERRAMENTAS NECESSÁRIAS

HERRAMIENTAS NECESARIAS

Lápis
Lápiz



Nível
Nivel



Furadeira
taladro



Broca vídea 8 mm
Broca videa



Chave 1/4
Llave



COMPONENTES

COMPONENTES

2 Divisória Vertical ①
Partición vertical



2 Divisória Horizontal ②
Partición horizontal

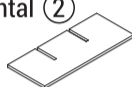

2 Buchas 8 mm
Bujes



2 Suportes
Soportes



15min

Instruções de instalação

Instrucciones de instalación

Encaixe as divisórias ② nas divisórias ①.

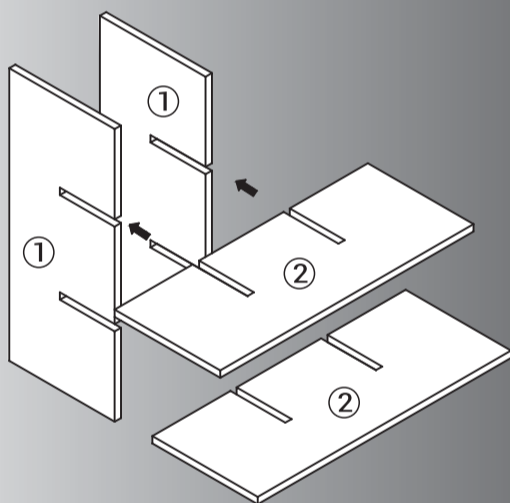

Marca e fura.

Distancia dos furos:
215 mm para montagem vertical
305 mm para montagem diagonal

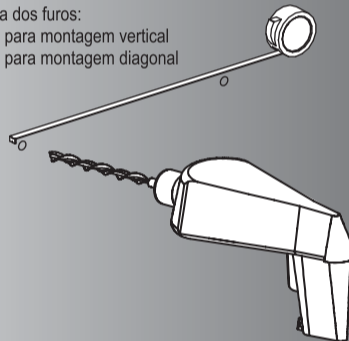

Vertical

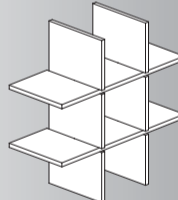

Diagonal

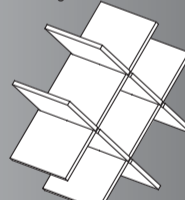

Encaixa!

Antes de fazer os furos,
assegure-se de que não
existam canos ou tubos
na parede.

Antes de hacer los agujeros,
asegúrese de que no hay
tuberías o tubos en la pared.

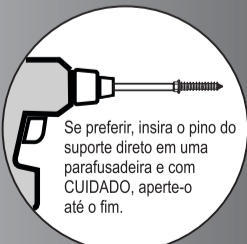
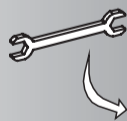

Se preferir, insira o pino do
suporte direto em uma
parafusadeira e com
CUIDADO, aperte-o
até o fim.

