

new job

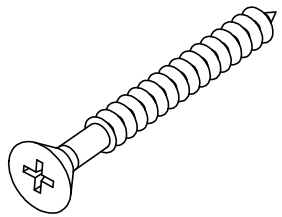

**A-Parafuso 4,5x 50
(x4)**

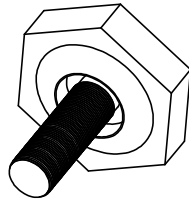

**B-Pé Regulavel
(x4)**



**C-Parafuso Flang 5 x 30
(x4)**

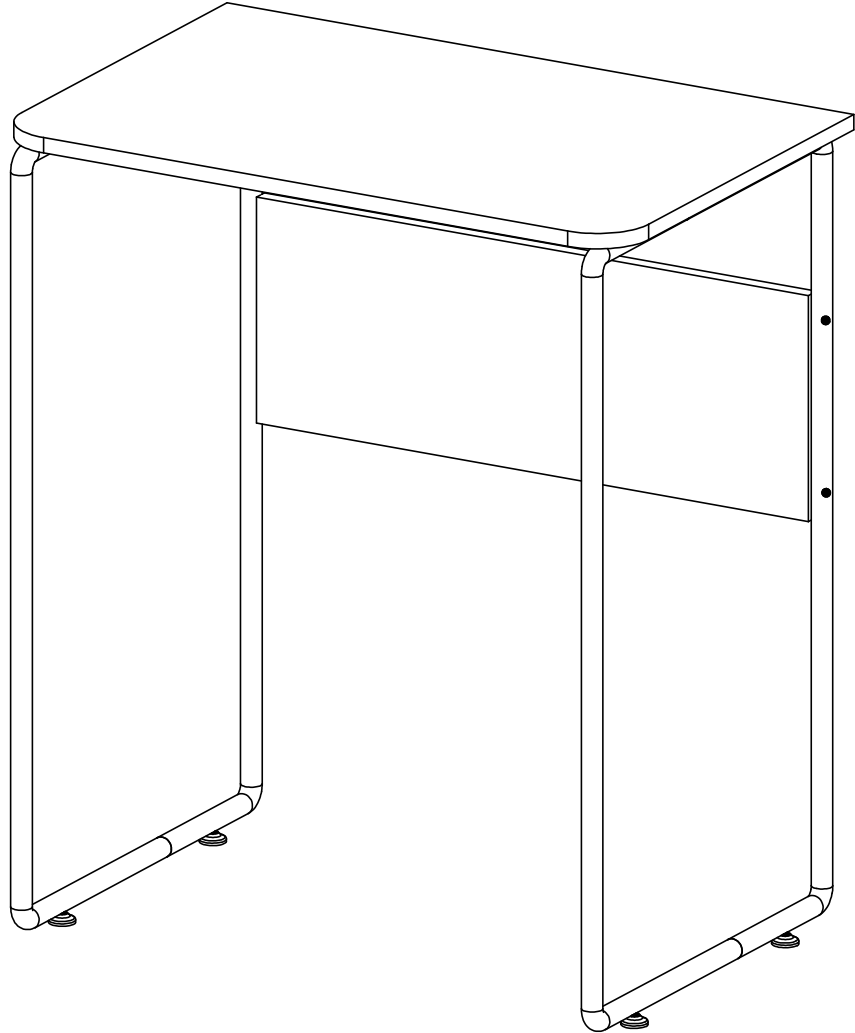

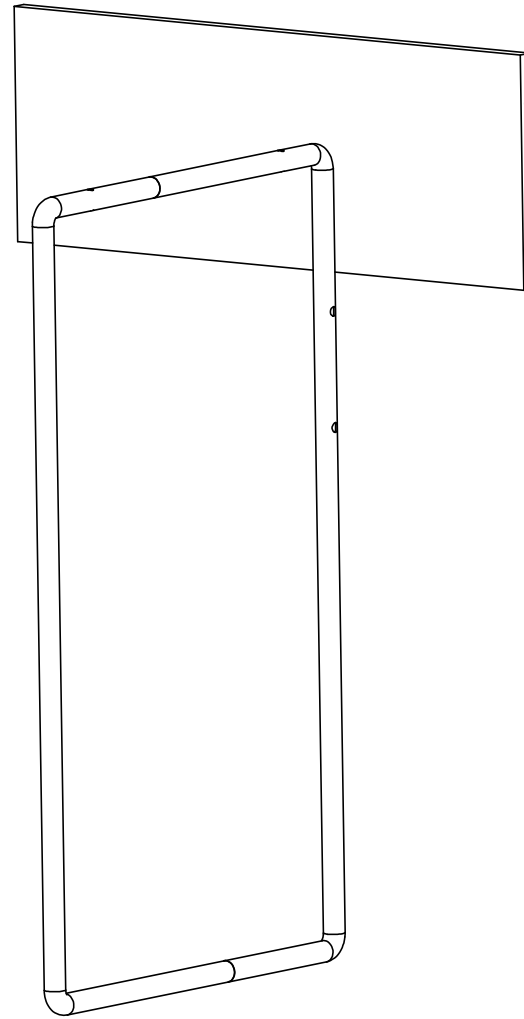
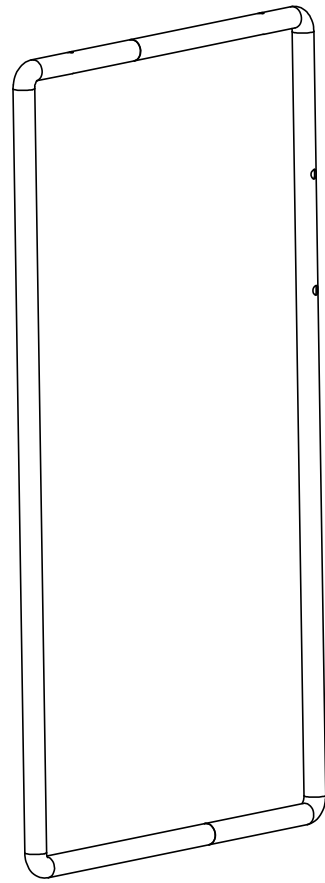
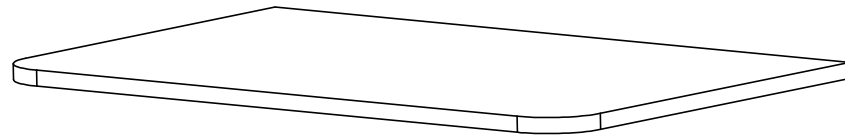

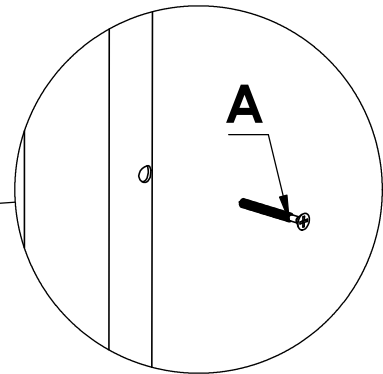
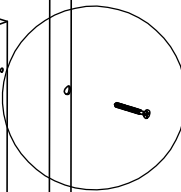
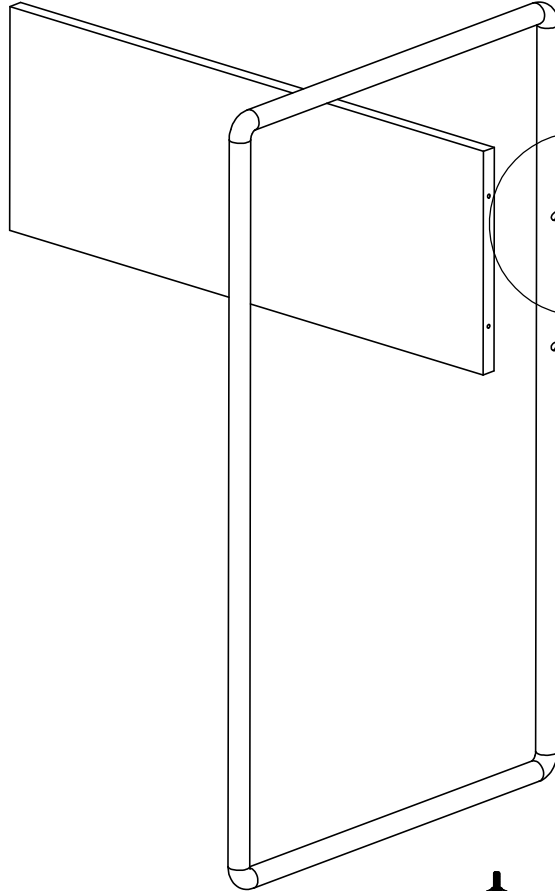
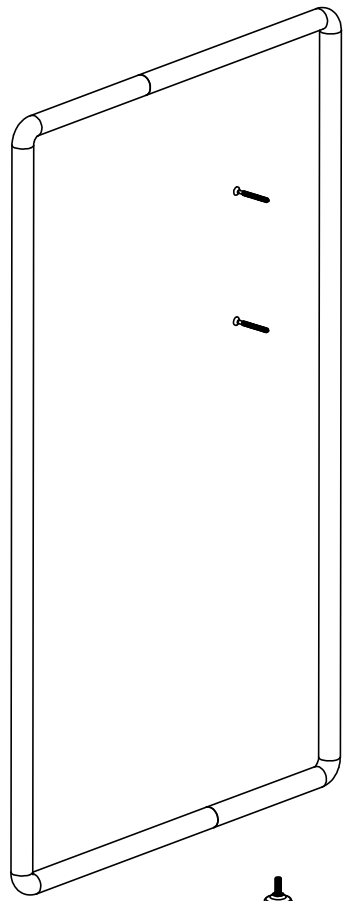

B

