



# CATÁLOGO DE PRODUTOS

LINHA DE SUPORTES PARA TV, ÁUDIO E VÍDEO  
LINHA DECORE

- 10K**
  - 8K**
  - 4K**
  - FULL HD HDR**
  - 4 EM 1**  
HDTV, UHF, VHF, FM
- IMAGEM E SOM  
100% DIGITAIS  
GRÁTIS
- HDTV
  - +
  - UHF
  - +
  - VHF
  - +
  - FM



2 OPÇÕES  
DE INSTALAÇÃO



# ATN 150 HD

ANTENA DIGITAL INTERNA

<b>BASE</b> MAGNÉTICA	<b>Full HD</b> 1080p	<b>HDTV</b> DIGITAL	ACOMPANHA <b>1,5 M</b> CABO COAXIAL
--------------------------	-------------------------	------------------------	-------------------------------------------

- 10K**
  - 8K**
  - 4K**
  - FULL HD HDR**
  - 4 EM 1**  
HDTV, UHF, VHF, FM
- IMAGEM E SOM  
100% DIGITAIS  
GRÁTIS
- HDTV
  - +
  - UHF
  - +
  - VHF
  - +
  - FM



2 OPÇÕES  
DE INSTALAÇÃO



# ATN 300 HD

ANTENA DIGITAL INTERNA

<b>BASE</b> MAGNÉTICA	<b>Full HD</b> 1080p	<b>HDTV</b> DIGITAL	ACOMPANHA <b>3 M</b> CABO COAXIAL
--------------------------	-------------------------	------------------------	-----------------------------------------

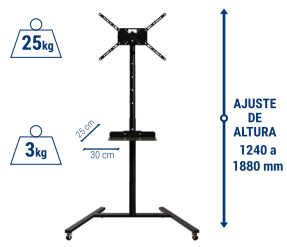

19" 56"

# PEDESTAL CLASS

SUPOORTE PARA TV BIARTICULADO E COM INCLINAÇÃO



VESA MÁXIMO 400 75 VESA MÍNIMO	INCLINAÇÃO <b>15°</b> (0°   8°   15°)	AJUSTES DE ALTURA	ORGANIZADOR DE CABOS
-----------------------------------------	---------------------------------------------	----------------------	-------------------------

O SUPORTE PARA TVs **GIGANTES!**  
Até 86"

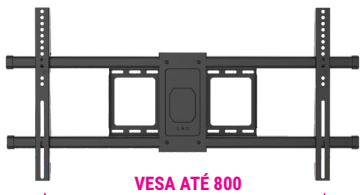

FÁCIL  
INSTALAÇÃO!



43" 86"

# MI860

SUPORTE PARA TV TRIARTICULADO E COM INCLINAÇÃO

PESO

**65kg**  
SUPPORTADO

VESA

**800x400**  
MÁXIMO

DISTÂNCIA

**72-408**  
mm  
DA PAREDE

INCLINAÇÃO

**15°**  
(-3°/+12°)

AJUSTE DE

**±3°**  
NÍVEL

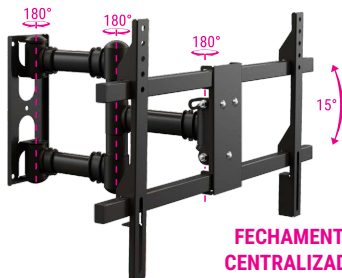

FECHAMENTO  
CENTRALIZADO!

DISTÂNCIA DA PAREDE

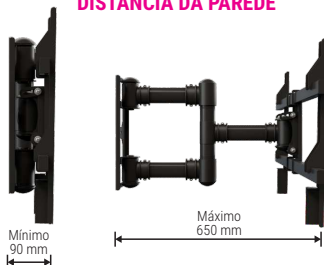

32" 75"

# STPA7000

SUPORTE PARA TV TRIARTICULADO E COM INCLINAÇÃO



PESO

**50kg**  
SUPPORTADO

VESA

**600x400**  
MÁXIMO

DISTÂNCIA

**90-650**  
mm  
DA PAREDE

INCLINAÇÃO

**15°**  
(0°/+15°)



ORGANIZADOR

DE CABOS



DISTÂNCIA DA PAREDE

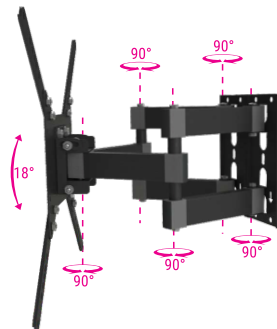
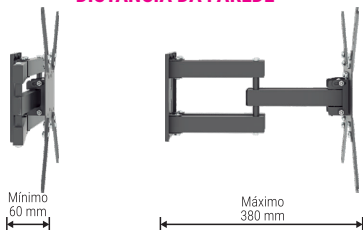

26" 75"

# STPA2000

SUPORTE PARA TV TRIARTICULADO E COM INCLINAÇÃO



PESO

**50kg**  
SUPPORTADO

VESA MÁXIMO

**400**  
100  
VESA MÍNIMO

DISTÂNCIA

**60-380**  
mm  
DA PAREDE

INCLINAÇÃO

**18°**  
(-6°/+12°)

AJUSTE DE

**±5°**  
NÍVEL

ORGANIZADOR

DE CABOS



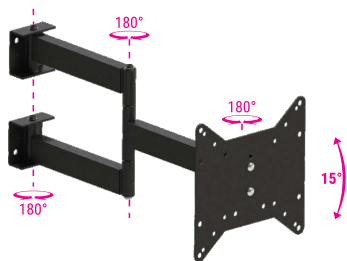

### DISTÂNCIA DA PAREDE

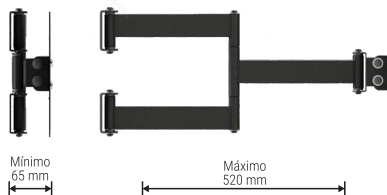

40" 70"

# STPA4070

SUPOORTE PARA TV TRIARTICULADO E COM INCLINAÇÃO



PESO <b>35kg</b> SUPPORTADO	VESA MÁXIMO <b>400</b> VESA MÍNIMO <b>100</b>	DISTÂNCIA <b>65-520</b> mm DA PAREDE	INCLINAÇÃO <b>15°</b> (-5°   +15°)	AJUSTE DE <b>±3°</b> NÍVEL
-----------------------------------	--------------------------------------------------------	-----------------------------------------------	------------------------------------------	----------------------------------

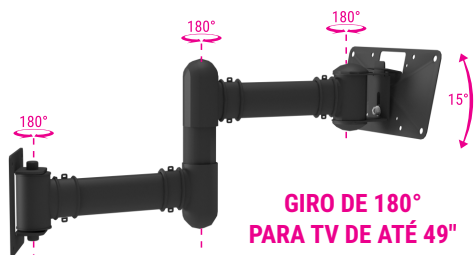

**GIRO DE 180°  
PARA TV DE ATÉ 49"**

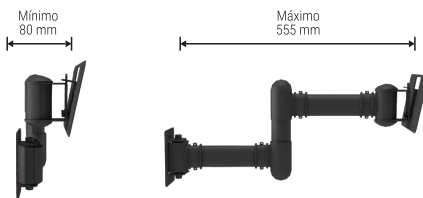

### DISTÂNCIA DA PAREDE

19" 56"

# STPA50

SUPOORTE PARA TV TRIARTICULADO E COM INCLINAÇÃO



PESO <b>30kg</b> SUPPORTADO	VESA MÁXIMO <b>400</b> VESA MÍNIMO <b>75</b>	DISTÂNCIA <b>80-555</b> mm DA PAREDE	INCLINAÇÃO <b>15°</b> (0°   +6°   +15°)	AJUSTE DE <b>±3°</b> NÍVEL	ORGANIZADOR DE CABOS
-----------------------------------	-------------------------------------------------------	-----------------------------------------------	-----------------------------------------------	----------------------------------	-------------------------

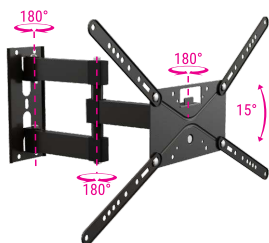

### DISTÂNCIA DA PAREDE

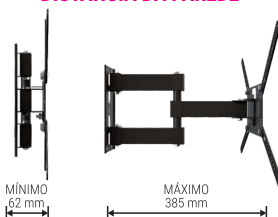

### 3 NÍVEIS DE INCLINAÇÃO



14" 56"

# STPA355

SUPOORTE PARA TV TRIARTICULADO E COM INCLINAÇÃO



PESO <b>35kg</b> SUPPORTADO	VESA MÁXIMO <b>400</b> VESA MÍNIMO <b>75</b>	DISTÂNCIA <b>62-385</b> mm DA PAREDE	INCLINAÇÃO <b>15°</b> (0°   +6°   +15°)	AJUSTE DE <b>±3°</b> NÍVEL	DISPONÍVEL NAS CORES BRANCO PRETO
-----------------------------------	-------------------------------------------------------	-----------------------------------------------	-----------------------------------------------	----------------------------------	--------------------------------------



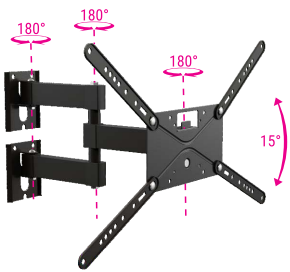

**DISTÂNCIA DA PAREDE**



14" 58"

# M3

SUPORTE PARA TV TRIARTICULADO E COM INCLINAÇÃO



<b>PESO</b> <b>25kg</b> SUPPORTADO	<b>VESA MÁXIMO</b> <b>400</b> <b>75</b> <b>VESA MÍNIMO</b>	<b>DISTÂNCIA</b> <b>62-380</b> mm DA PAREDE	<b>INCLINAÇÃO</b> <b>15°</b> (0°   6°   15°)	<b>AJUSTE DE</b> <b>±3°</b> NÍVEL
------------------------------------------	---------------------------------------------------------------------	------------------------------------------------------	----------------------------------------------------	-----------------------------------------



Sistema de passagem de cabos

**3 NÍVEIS DE INCLINAÇÃO**

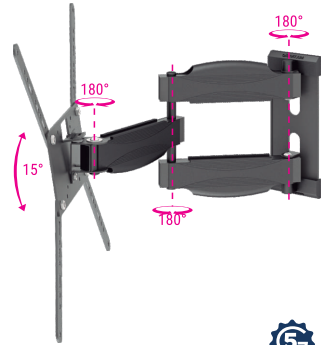

14" 56"

# STPA MAX

SUPORTE PARA TV TRIARTICULADO E COM INCLINAÇÃO



<b>PESO</b> <b>35kg</b> SUPPORTADO	<b>VESA MÁXIMO</b> <b>400</b> <b>75</b> <b>VESA MÍNIMO</b>	<b>DISTÂNCIA</b> <b>60-400</b> mm DA PAREDE	<b>INCLINAÇÃO</b> <b>15°</b> (0°   +6°   +15°)	<b>AJUSTE DE</b> <b>±3°</b> NÍVEL	<b>ORGANIZADOR</b> DE CABOS	 PRONTO PARA INSTALAR
------------------------------------------	---------------------------------------------------------------------	------------------------------------------------------	------------------------------------------------------	-----------------------------------------	--------------------------------	--------------------------

**DISTÂNCIA DA PAREDE**

Mínimo 95 mm

Máximo 330 mm

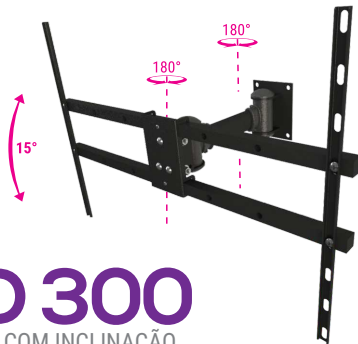
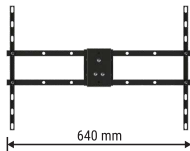

40" 75"

# SUPER HD 300

SUPORTE PARA TV BIARTICULADO E COM INCLINAÇÃO



<b>PESO</b> <b>35kg</b> SUPPORTADO	<b>VESA MÁXIMO</b> <b>600x400</b> <b>200x200</b> <b>VESA MÍNIMO</b>	<b>DISTÂNCIA</b> <b>95-330</b> mm DA PAREDE	<b>INCLINAÇÃO</b> <b>15°</b> (0°   6°   15°)	<b>AJUSTE DE</b> <b>±3°</b> NÍVEL
------------------------------------------	------------------------------------------------------------------------------	------------------------------------------------------	----------------------------------------------------	-----------------------------------------

### 3 NÍVEIS DE INCLINAÇÃO



Sistema de passagem de cabos

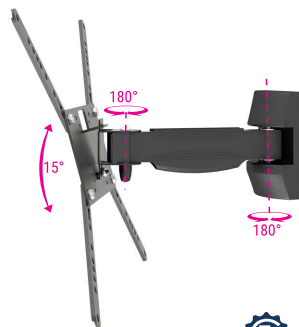

14" 56"

## STPA46

SUPOORTE PARA TV BIARTICULADO E COM INCLINAÇÃO



PESO

**25kg**

SUPORTADO

VESA MÁXIMO

**400**

**75**

VESA MÍNIMO

DISTÂNCIA

**60-270**

mm  
DA PAREDE

INCLINAÇÃO

**15°**

(0° | +6° | +12°)

AJUSTE DE

**±3°**

NÍVEL

ORGANIZADOR

DE CABOS

### DISTÂNCIA DA PAREDE

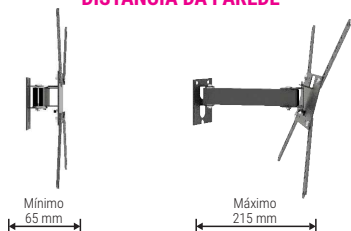

Mínimo  
65 mm

Máximo  
215 mm

14" 56"

## M2

SUPOORTE PARA TV BIARTICULADO E COM INCLINAÇÃO



PESO

**25kg**

SUPORTADO

VESA MÁXIMO

**400**

**75**

VESA MÍNIMO

DISTÂNCIA

**65-215**

mm  
DA PAREDE

INCLINAÇÃO

**15°**

(0° | 6° | 15°)

AJUSTE DE

**±3°**

NÍVEL

### DIMENSÕES DO SUPORTE

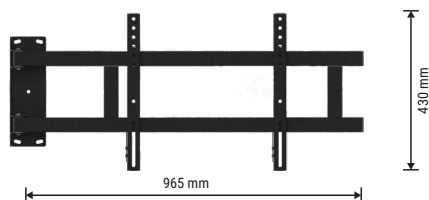

965 mm

430 mm

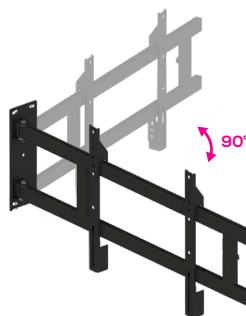

90°

43" 65"

## STPA 90

SUPOORTE PARA TV ARTICULADO



PESO

**35kg**

SUPORTADO

VESA

**600x400**

MÁXIMO

AJUSTE DE

**±3°**

NÍVEL

ÂNGULO DE

**90°**

EM RELAÇÃO A FIXAÇÃO

DISTÂNCIA

**55**

mm  
DA PAREDE



PRONTO PARA  
INSTALAR



Sistema anti-roubo

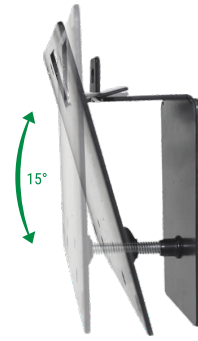

14" 56"

# STPA550

SUPORTE PARA TV COM INCLINAÇÃO



PESO <b>35kg</b> SUPPORTADO	VESA MÁXIMO <b>400</b> 75 VESA MÍNIMO	DISTÂNCIA <b>45</b> mm DA PAREDE	INCLINAÇÃO <b>15°</b> (0°   +15°)	SISTEMA  ANTI-ROUBO	 PRONTO PARA INSTALAR
-----------------------------------	------------------------------------------------	-------------------------------------------	-----------------------------------------	---------------------------	-----------------------------



## AJUSTE DE INCLINAÇÃO COM UM TOQUE

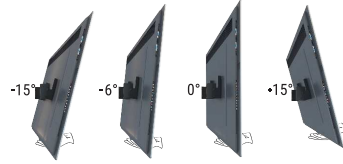

Ajuste para TV instalada acima da altura dos olhos

Ajuste para evitar reflexos de janelas e outros

Ajuste para TV instalada na altura dos olhos

Ajuste para facilitar o acesso aos cabos

10" 65"

# TOUCH

SUPORTE PARA TV COM INCLINAÇÃO



PESO <b>30kg</b> SUPPORTADO	VESA MÁXIMO <b>400</b> 75 VESA MÍNIMO	DISTÂNCIA <b>95</b> mm DA PAREDE	INCLINAÇÃO <b>15°</b> (-15°   -6°   0°   +15°)		 PRONTO PARA INSTALAR
-----------------------------------	------------------------------------------------	-------------------------------------------	------------------------------------------------------	--	-----------------------------



2 OPÇÕES DE AJUSTE DE ALTURA



AJUSTE FINO HORIZONTAL

32" 65"

# STPF66

SUPORTE PARA TV FIXO



PESO <b>60kg</b> SUPPORTADO	VESA MÁXIMO <b>400</b> 75 VESA MÍNIMO	DISTÂNCIA <b>25</b> mm DA PAREDE	 PRONTO PARA INSTALAR
-----------------------------------	------------------------------------------------	-------------------------------------------	-----------------------------

INCLINAÇÃO

FIXO

## INSTALAÇÃO FÁCIL E SEGURA



1  
Leve a TV em direção à parede com o suporte já instalado.



2  
Alinhe as roldanas no encaixe dos suportes.



3  
Abaixar a TV até encaixar perfeitamente.



14" 100"

# INFINITI

SUPORE PARA TV FIXO



PESO  
**100 kg**  
SUPPORTADO

FIXAÇÃO  
**UNIVERSAL**

DISTÂNCIA  
**40 mm**  
DA PAREDE

AJUSTE FINO  
**30 mm**  
HORIZONTAL



## MAIS LEVE E MAIS SEGURO

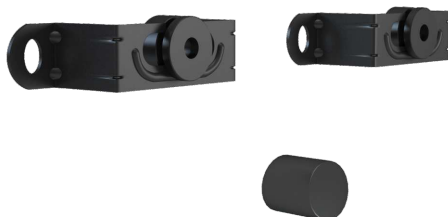

Ajuste fino horizontal para centralização da TV até 30 mm para cada lado

14" 84"

# M1

SUPORE PARA TV FIXO



PESO  
**100 kg**  
SUPPORTADO

FIXAÇÃO  
**UNIVERSAL**

DISTÂNCIA  
**35 mm**  
DA PAREDE

AJUSTE FINO  
**30 mm**  
HORIZONTAL

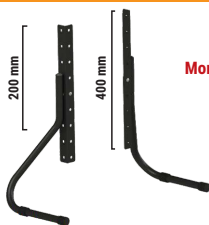

Distância conforme o VESA

**2 EM 1**  
Monte conforme a fixação da TV

As Curvas Garantem  
+ ESTABILIDADE  
+ SEGURANÇA



PÉS ANTI-DESGLIZANTES



32" 75"

# STAND 200

BASE PARA TV COM AJUSTE DE ALTURA



PESO  
**36 kg**  
SUPPORTADO

VESA  
**800x400**  
MÁXIMO

AJUSTES  
DE ALTURA





SISTEMA  
ANTI-VIBRAÇÃO



ORGANIZADOR  
DE CABOS



# SPHT 460

PAR DE SUPORTES PARA HOME THEATER

PESO

**10kg**

SUPORTADO

FIXAÇÃO

**UNIVERSAL**

## DIMENSÕES DO PRODUTO



FÁCIL INSTALAÇÃO



# AERO-01

SUPORTE PARA ACESSÓRIOS



PESO

**6 kg**

SUPORTADO



## DIMENSÕES DO PRODUTO



FÁCIL INSTALAÇÃO



# AERO-02

SUPORTE PARA ACESSÓRIOS



PESO

**6 kg**

SUPORTADO



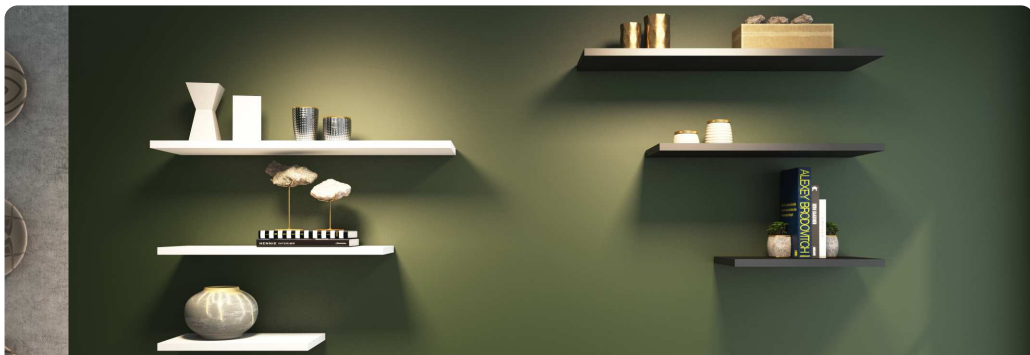

### PRATELEIRAS DECORATIVAS

CORES  
DISPONÍVEIS



PESO  
SUPPORTADO



INSTALAÇÃO  
10 MIN



10 x 40

10 x 60

20 x 40

20 x 60

20 x 80

20 x 100

25 x 60

25 x 80

25 x 100

30 x 60

30 x 80

30 x 100



cm (PxL)



### PRATELEIRAS ALPHA

CORES  
DISPONÍVEIS



PESO  
SUPPORTADO



INSTALAÇÃO  
20 MIN



cm

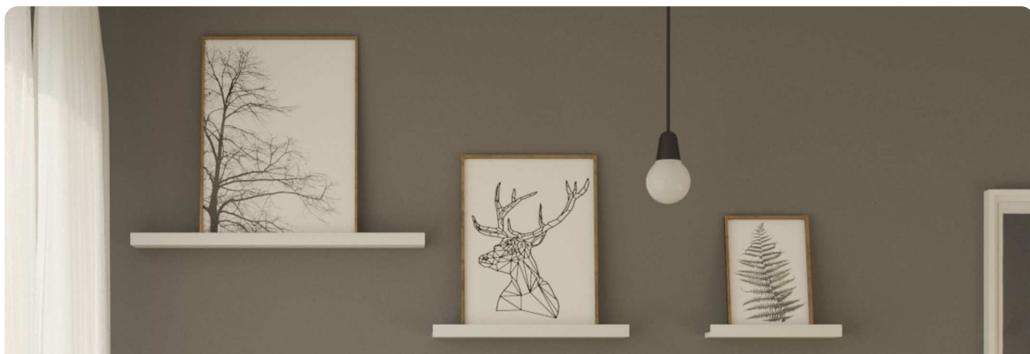

### PORTA QUADROS

CORES  
DISPONÍVEIS



PESO  
SUPPORTADO



INSTALAÇÃO  
20 MIN



10 x 40

10 x 60

10 x 90



cm (PxL)

### KIT CLIP

CORES DISPONÍVEIS

PESO SUPORTADO

INSTALAÇÃO 10 MIN

MARCA, FURA E ENCAIXA!

10 x 40	20 x 80	25 x 60
20 x 40	20 x 100	25 x 80
20 x 60	25 x 40	25 x 100

1,5 cm (PxL)

### KIT BELLE

CORES DISPONÍVEIS

PESO SUPORTADO

INSTALAÇÃO 10 MIN

MARCA, FURA E ENCAIXA!

10 x 40	20 x 80	25 x 60
20 x 40	20 x 100	25 x 80
20 x 60	25 x 40	25 x 100

1,5 cm (PxL)

### LINHA SIDE

CORES DISPONÍVEIS

INSTALAÇÃO 10 MIN

MARCA, FURA E ENCAIXA!

20 x 60	10 kg DISTRIBUÍDOS
20 x 120	15 kg DISTRIBUÍDOS
20 x 180	20 kg DISTRIBUÍDOS

1,5 cm (PxL)



PRAT-ARM 1P  
17,4 x 60 x 21,6  
25 kg  
DISTRIBUIDOS



PRAT-ARM 2P  
36,1 x 60 x 21,6  
15 kg  
DISTRIBUIDOS



PRAT-ARM 3P  
55,1 x 60 x 21,6 cm  
15 kg  
DISTRIBUIDOS

## LINHA AÇO E MADEIRA

CORES  
DISPONÍVEIS



INSTALAÇÃO

20 MIN

MARCA, FURA  
E ENCAIXA!



cm (AxLxP)



## KIT DE PRATELEIRAS MULTIUSO

CORES  
DISPONÍVEIS



PESO  
SUPPORTADO



INSTALAÇÃO

30 MIN

MARCA, FURA  
E ENCAIXA!



40 x 63 x 20,3



cm (AxLxP)

## KIT DE PRATELEIRAS COM SUPORTES DE AÇO

## KIT 2Z

CORES  
DISPONÍVEIS



PESO  
SUPPORTADO



INSTALAÇÃO

20 MIN

MARCA, FURA  
E ENCAIXA!



22 x 50 x 40



cm (AxLxP)

SUPORTA QUALQUER  
OBJETO COM BASE  
RETA ATÉ 60 CM DE  
PROFUNDIDADE

### F-DECOR

CORES  
DISPONÍVEIS



PESO  
SUPORTADO



INSTALAÇÃO

20 MIN

MARCA, FURA  
E ENCAIXA!



SUPORTE COM RODÍZIOS  
PARA ELETROMÉSTICOS

### SED-M-BR

COR  
DISPONÍVEL



PESO  
SUPORTADO



MONTAGEM

20 MIN

FÁCIL DE MONTAR!  
COM ORÇAMENTO DECOR.



Com ajuste de dimensões:  
700 mm Máxima  
500 mm Mínima

RODÍZIOS COM TRAVA

DIMENSÕES AJUSTÁVEIS

FECHADA

ABERTA

### MESA DOBRÁVEL

CORES  
DISPONÍVEIS



PESO  
SUPORTADO



INSTALAÇÃO

20 MIN

MARCA, FURA  
E ENCAIXA!



50 x 40  
90 x 40  
100 x 50

15  
I  
cm (LxP)



### GAVETEIRO MULTIUSO

CORES  
DISPONÍVEIS



MONTAGEM

30 MIN

FÁCIL DE MONTAR!  
CHE. ORGANIZE. DECORE.

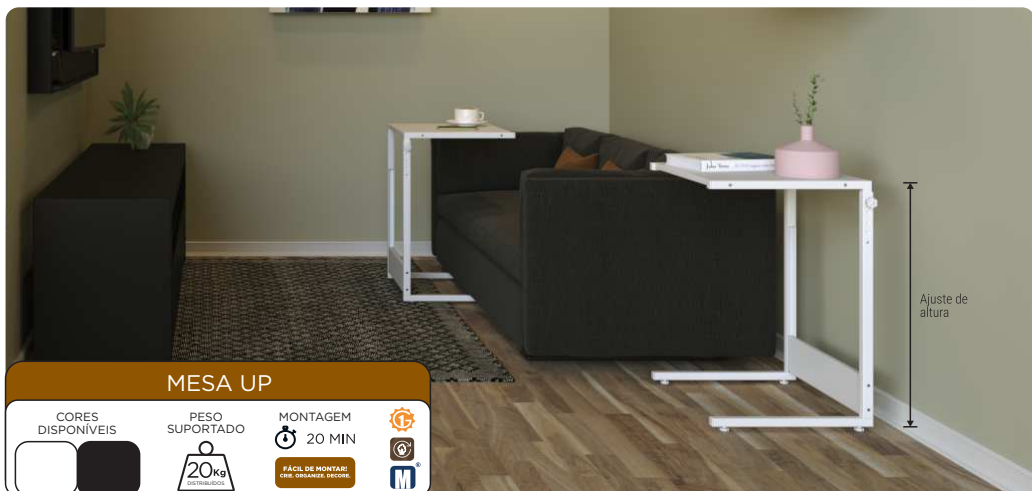

### MESA UP

CORES  
DISPONÍVEIS



PESO  
SUPORTADO



MONTAGEM

20 MIN

FÁCIL DE MONTAR!  
CHE. ORGANIZE. DECORE.



Ajuste de  
altura



GABINETE PARA GALÃO  
DE ÁGUA COM PORTA  
PARA GALÃO RESERVA

### GALLON

COR  
DISPONÍVEL



MONTAGEM

30 MIN

FÁCIL DE MONTAR!  
CHE. ORGANIZE. DECORE.





### ESTANTES DE PLÁSTICO COM RODÍZIOS

COR DISPONÍVEL

PESO SUPORTADO

MONTAGEM

20 MIN

8kg

FÁCIL DE MONTAR! CHE, ORGANIZE, DECORE.

6 TAMANHOS DISPONÍVEIS



2 Opções de montagem:

Prateleira

Bandeja

### LINHA STRONGER

CORES DISPONÍVEIS

PESO SUPORTADO

MONTAGEM

20 MIN

60kg

FÁCIL DE MONTAR! CHE, ORGANIZE, DECORE.

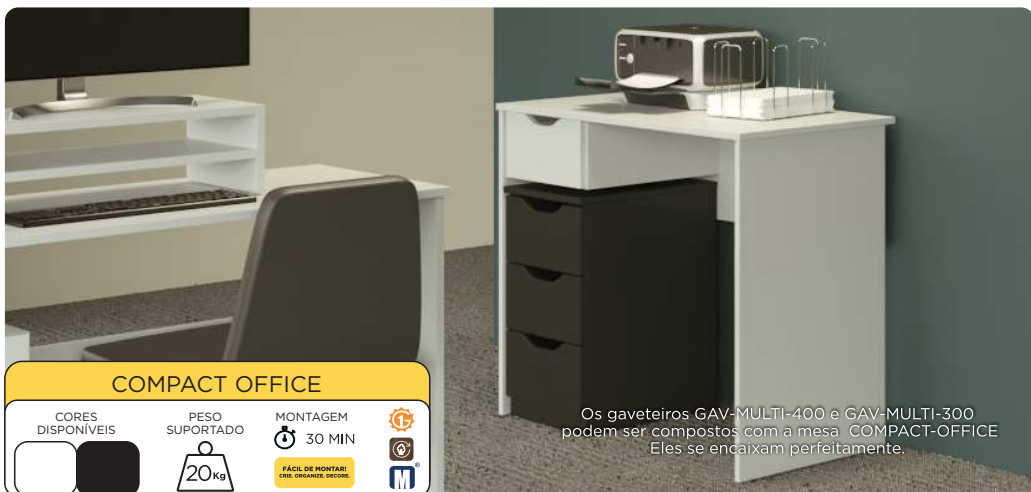

### COMPACT OFFICE

CORES DISPONÍVEIS

PESO SUPORTADO

MONTAGEM

30 MIN

20kg

FÁCIL DE MONTAR! CHE, ORGANIZE, DECORE.

Os gaveteiros GAV-MULTI-400 e GAV-MULTI-300 podem ser compostos com a mesa COMPACT-OFFICE. Eles se encaixam perfeitamente.

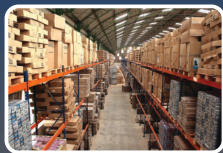

Acesse aqui nossas  
redes sociais.



Rua Coronel José Nunes dos Santos, 640 | Centro | 06730-000 | Vargem Grande Paulista | SP | Brasil  
CNPJ 54.817.853/0001-40 | +55 11 4158-8700 | contato@multivisao.com.br

Outubro 2022