

2

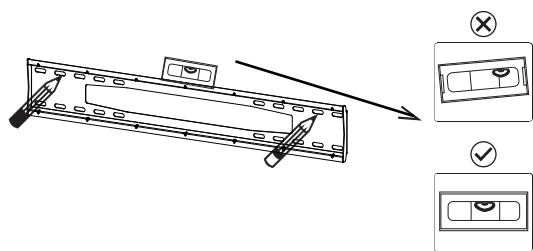

⚠ Marque o local da perfuração para a régua.
Use o nível para garantir o nivelamento.

Faça 4 furos

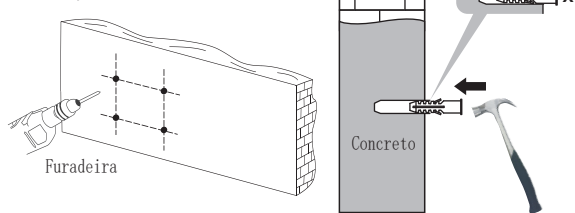

Insira as buchas nos furos.

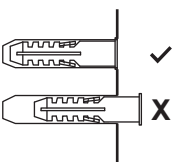

Anchors can be just used for concrete wall , not for wood or stud.

3

Prenda a régua na parede usando os parafusos de fixação

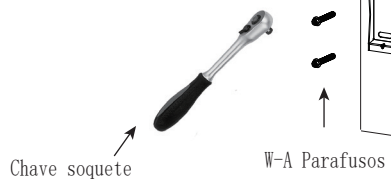

4

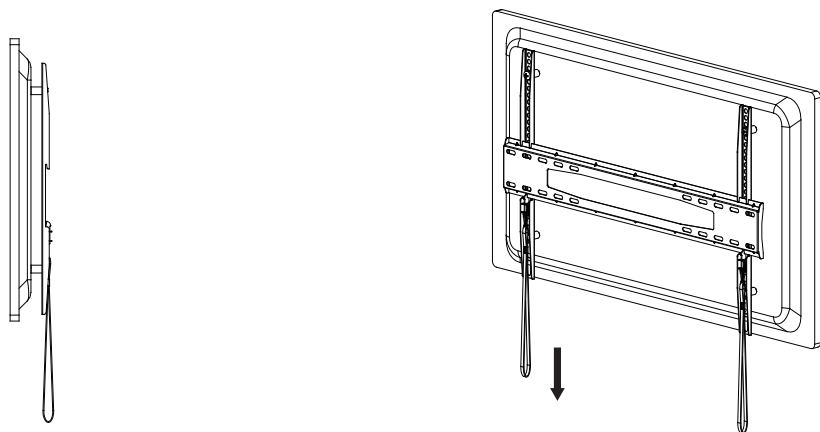

Pendure a TV na Régua da parede e empurre a alça para baixo para prender as hastes na régua.



Instruções de instalação
Instrucciones de instalación

HD-598L

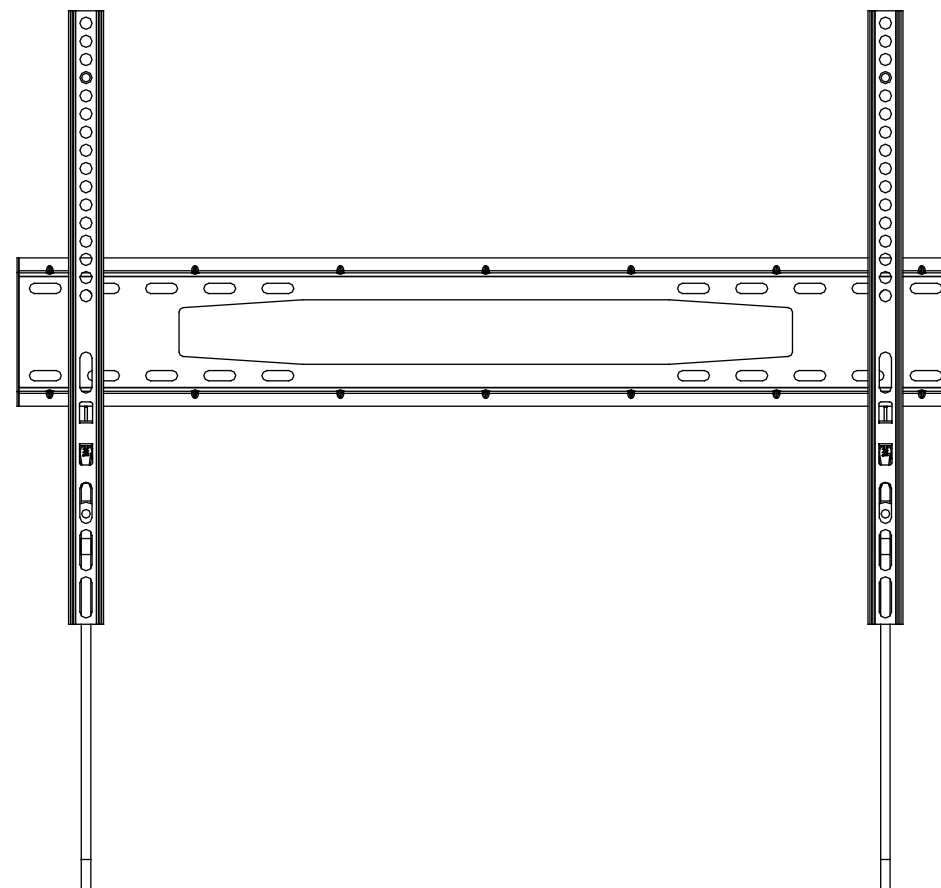

SAC
sac@multivisao.com.br
multivisao.com.br
☎ 11 4158-8700 ☎ 11 97338-5258

Produto indicado para ambiente interno.
Dicas de limpeza: Utilizar pano limpo e seco.
Nunca use produtos abrasivos
Acesse o termo de garantia em:
multivisao.com.br/termos/termosuporte.pdf



ATENÇÃO
Ferramentas
necessárias



Capacidade

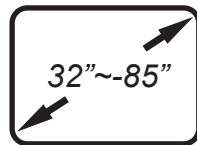

Polegadas suportadas



Furadeira



Chave Phillips



Trena



Chave soquete

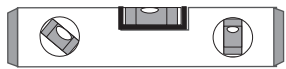

Nível



Broca Ø10



Lápis

Conjunto para parede

W-A. Parafuso
ST6.3 x 150mm



x4

W-B. Bucha
Ø10 Ø6 L50mm



x4

Conjunto para a TV

M-A. Parafuso
Phillips
M4*35mm



x4

M-B. Parafuso
Phillips
M6*35mm



x4

M-C. Parafuso
Phillips
M8*35mm

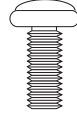

x4

M-D. Arruela



x4

Régua

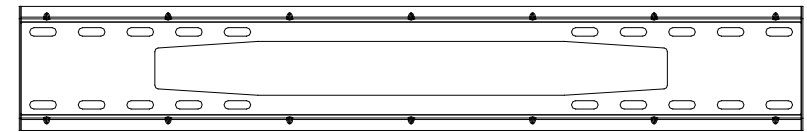

Hastes



1

Fixe as hastes na TV



Selecione os parafusos adequados para o kit do monitor

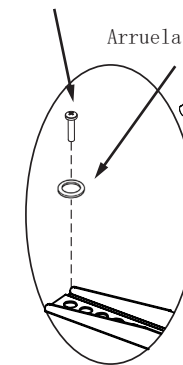
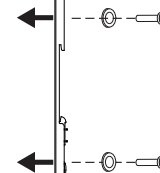

Arruela (opcional)

