

2

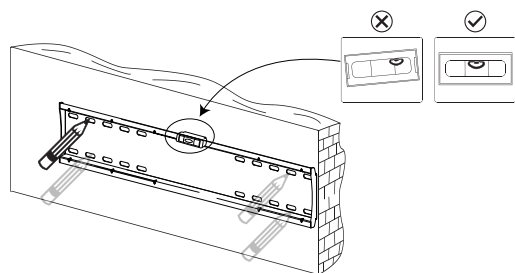

⚠ Marque o local da perfuração para a régua.
Use o nível para garantir o nivelamento.

Faça 4 furos

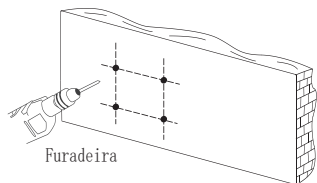

Furadeira

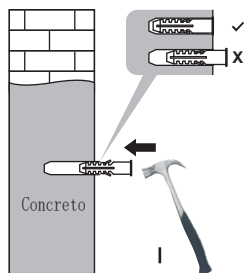

Concreto

Insira as buchas nos furos.

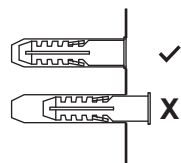

As buchas podem ser usadas apenas para paredes de concreto, não para paredes ou vigas de madeira.

3

Prenda a régua na parede usando os parafusos
de fixação

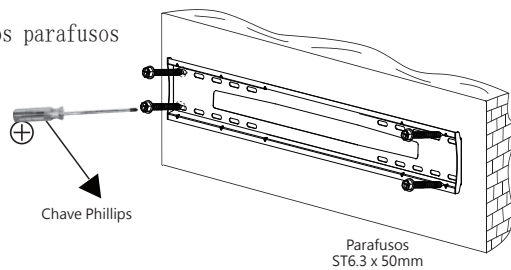

Chave Phillips

Parafusos
ST6.3 x 50mm

4

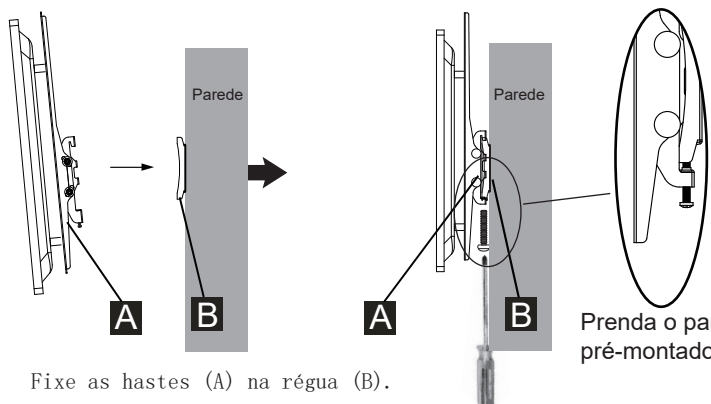

Fixe as hastes (A) na régua (B).

Prenda o parafuso
pré-montado M4 x 30mm

Instruções de instalação
Instrucciones de instalación

HD-599L

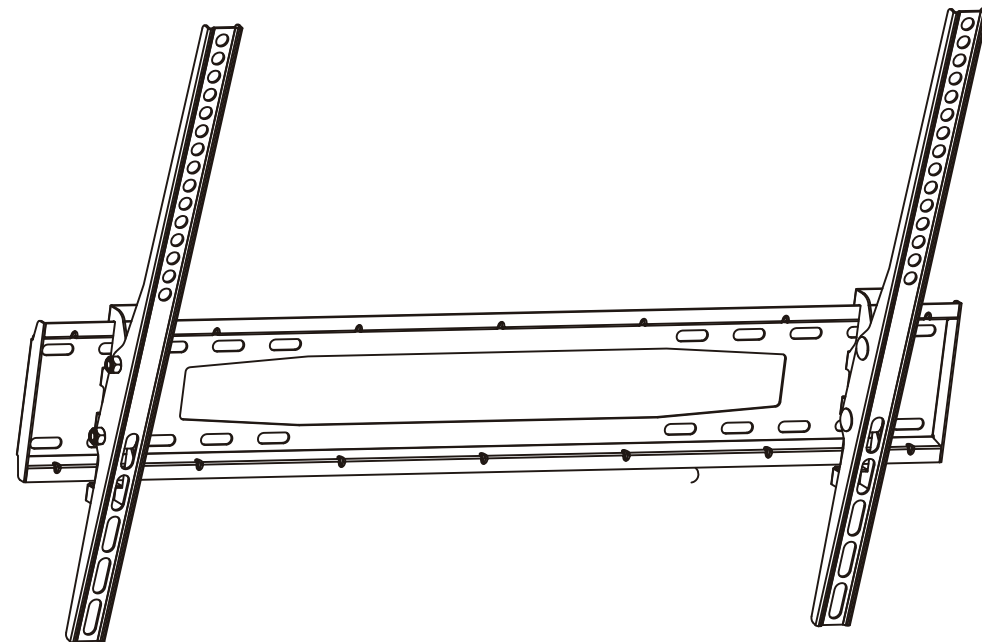

SAC
sac@multivisao.com.br
multivisao.com.br
☎ 11 4158-8700 ☎ 11 97338-5258

Produto indicado para ambiente interno.
Dicas de limpeza: Utilizar pano limpo e seco.
Nunca use produtos abrasivos
Acesse o termo de garantia em:
multivisao.com.br/termos/termosuporte.pdf



ATENÇÃO
Ferramentas
necessárias



Capacidade
55 KG

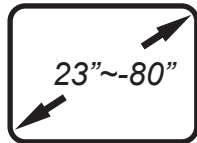

Polegadas suportadas
23''~80''



Furadeira



Chave Phillips



Trena



Lápis

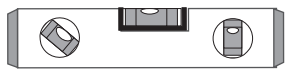

Nível



Broca Ø10

Conjunto para parede

W-A. Parafuso
ST6.3 x L50mm



x4

W-B. Bucha
Ø10 Ø6 L50mm



x4

Conjunto para a TV

Parafuso Phillips
M4 x 35mm

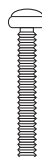

x4

Parafuso Phillips
M6 x 35mm

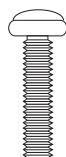

x4

Espaçador
L20mm



x4

Arruela



x4

Régua

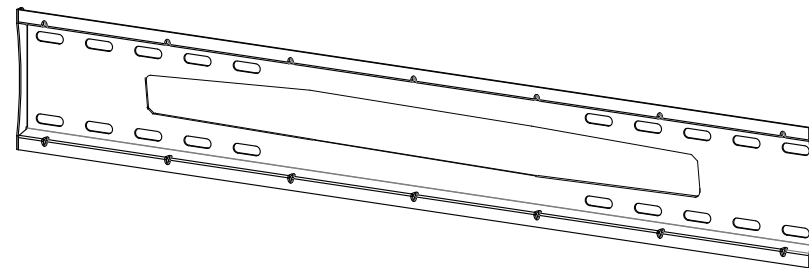

Hastes

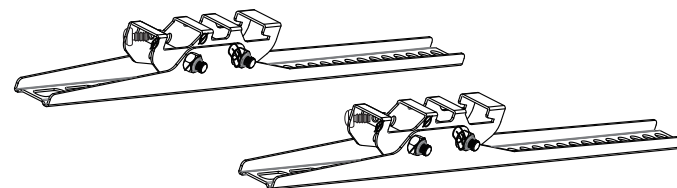

1

Fixe as hastes na sua TV. Selecione os parafusos que se ajustam à sua TV, use os espaçadores e as arruelas se necessário.



Use os espaçadores se necessário

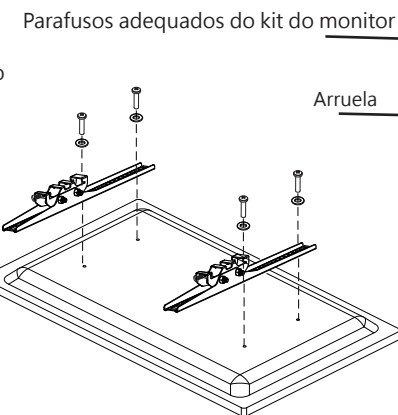
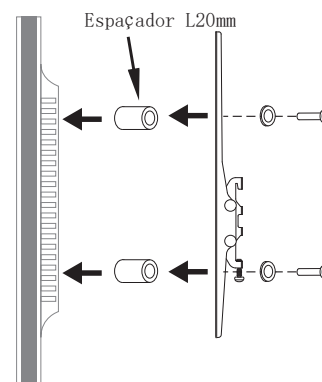

1. Certifique-se de que as hastes estejam bem fixadas na furação VESA.
2. Não aperte os parafusos com muita força e certifique-se de que os parafusos não sejam mais longos do que a furação.